

KardCom by PONTECH

licensed under a Creative Commons Attribution 3.0 US License

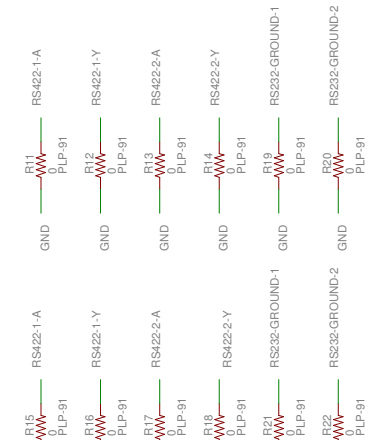
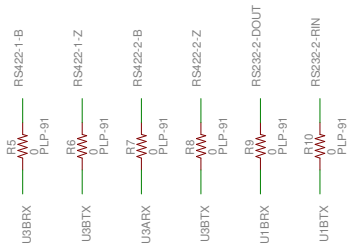
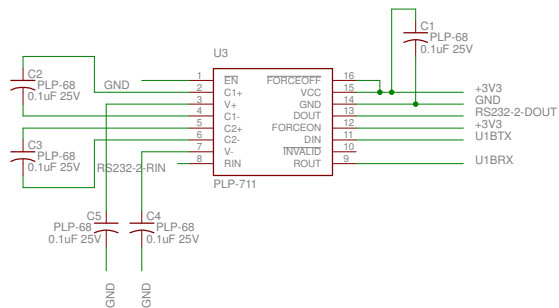
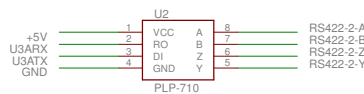
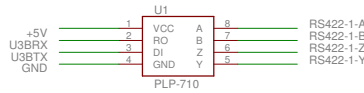
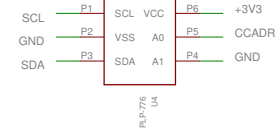
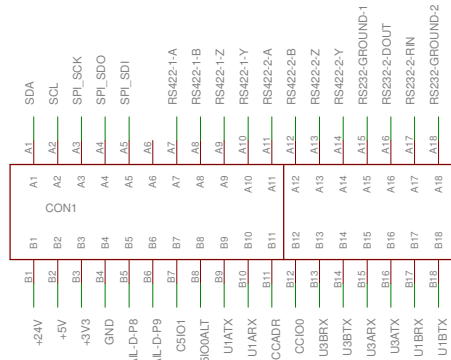
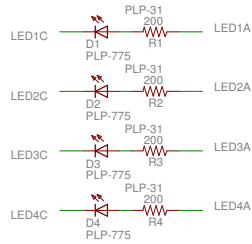

TITLE: KardCom	
Document Number: PLPB-0042	REV: X1
Date: 5/30/2014 3:55:09 PM	Sheet: 1/1